

Data Sheet



Article number: 201362NI8040ABL

Description: E+G Hinge for welding GN 1362-NI-80-40-A-BL
Stainless steel AISI 304

Measures

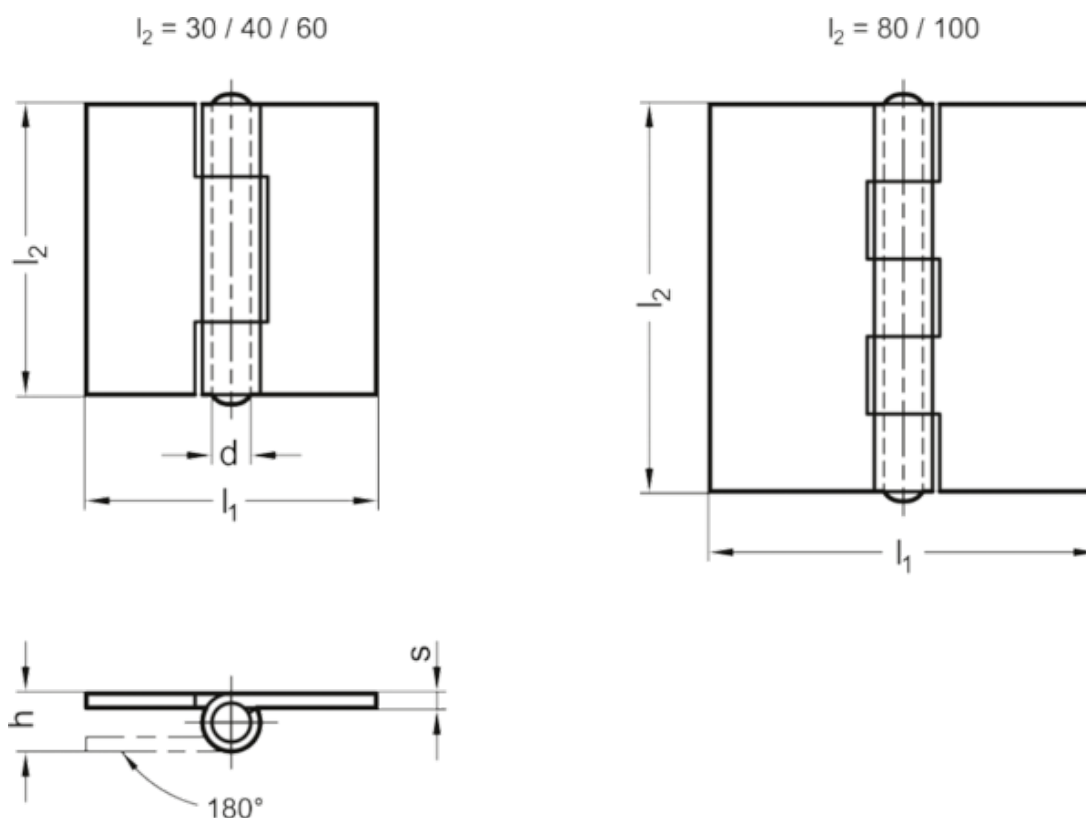

d	= 6
h	= 12
l1	= 80
l2	= 40
s	= 3
Weight in (g)	= 170